



PIRANHA COOLING LINE®

For extreme Cooling



Passt auf alle gängigen Werkzeugträger und CNC Maschinen
Fits on all standard tool holders and CNC machines



Ist flexibel – verstellbar ohne Werkzeuge
Is flexible – adjustable without tools



Bis 80 Bar Hochdruck einsetzbar
Withstands pressures up to 80 bar



Vielseitige Verwendung (kühlen, ausblasen, absaugen)
Versatile use (cooling, blowing out, suction)



Variabel anwendbar und vielseitig kombinierbar
Variably applicable and versatile in combination



Lange Lebensdauer durch Eloxalschicht
Long lifespan thanks to anodic coating



Geringes Gewicht
Light weight



Neues Design
New design



100% Swiss Made
100% Swiss made

Die patentierte
The patented

**PIRANHA
COOLING LINE**

**löst alle Kühlprobleme
bei der spanabhebenden
Bearbeitung**
solves all cooling problems
on chip-removing processing

Piranha Cooling Line

Die patentierte Piranha Cooling Line ist ein einzigartiges und vielseitiges Gelenkschlauchsystem zur präzisen Kühlmittel-, Öl- und Luftzufuhr. Aus hochfestem Aluminium gefertigt und eloxiert, hält es Drücke bis 80 bar stand, findet aber auch bei niedrigem Druck Anwendung, wo andere KSS-Leitungen frühzeitig verschleissen. Es lässt sich mit den erhältlichen Gewinde- bzw. Kugelanschlüssen auf allen gängigen Werkzeugträgern und CNC-Maschinen vorwiegend an Drehmaschinen, Fräsmaschinen, Schleifmaschinen, Sägemaschinen und Abfüllanlagen montieren. Neben der Kühl-Schmierstoffzufuhr eignet sich das Cooling Line-System ebenfalls zum Ausblasen von Spannfuttern und Werkstücken sowie zum Vorwärmen von Material beim 3D-Druck.

The Piranha Cooling Line is a unique and versatile jointed hose system for precise coolant supply. Made of high-strength anodized aluminium, it withstands pressures of up to 80 bar but can also be used at low pressures, where other cooling lubricant pipes wear prematurely. With our threaded connectors or ball connectors it can be installed on all common tool holders and CNC machines, mainly on turning machines, milling machines, grinding machines, sawing machines and filling plants. In addition to the cooling lubricant supply, the Cooling Line system is suitable for blowing out chucks or workpieces and for preheating material during 3D printing.

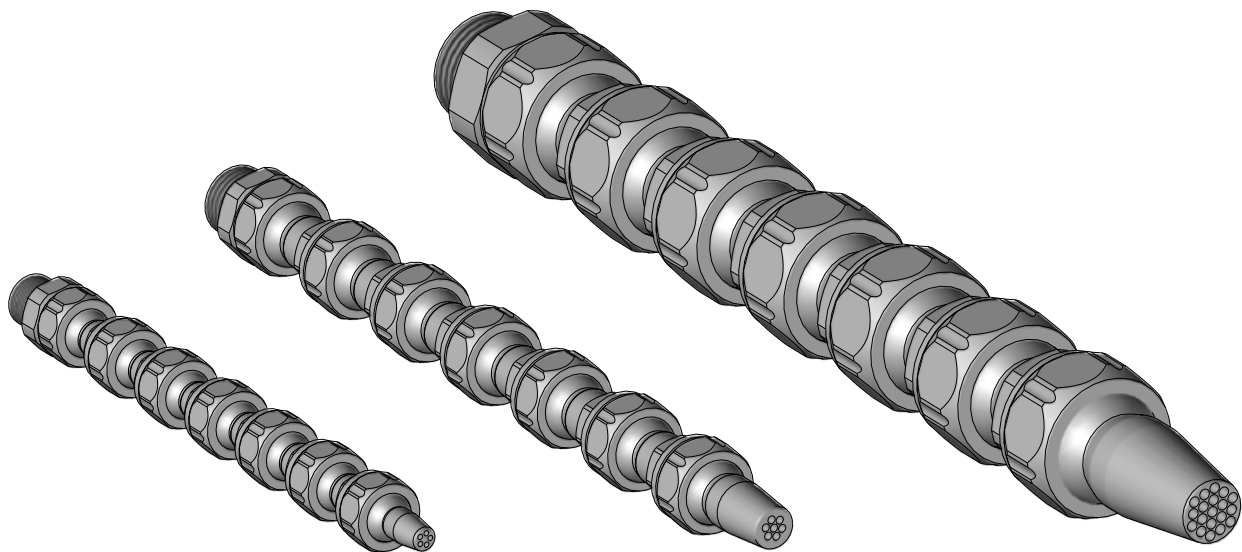

1/8" SYSTEM

Durchlass Ø 3,4 mm
Passage Ø 3,4 mm

Anzugsmoment 2 – 3 Nm
Clamping torque 2 – 3 Nm

Seite / page 3 – 5

1/4" SYSTEM

Durchlass Ø 5,5 mm
Passage Ø 5,5 mm

Anzugsmoment 2,5 – 3 Nm
Clamping torque 2,5 – 3 Nm

Seite / page 6 – 11

1/2" SYSTEM

Durchlass Ø 12,0 mm
Passage Ø 12,0 mm

Anzugsmoment 5 – 7,5 Nm
Clamping torque 5 – 7,5 Nm

Seite / page 12 – 15

FOR HIGH PRESSURE 80 BAR

Gewindeanschlüsse
Threaded connector

GA-9.5-1/8"

Gewindeanschluss 1/8" G
Threaded connector 1/8" G



GA-9.5-1/8" NPT

Gewindeanschluss 1/8" NPT
Threaded connector 1/8" NPT



GA-9.5-1/8" R

Gewindeanschluss 1/8" R
Threaded connector 1/8" R



GA-9.5-1/4" R

Gewindeanschluss 1/4" R
Threaded connector 1/4" R



GA-9.5-M8

Gewindeanschluss M8
Threaded connector M8



GA-9.5-M8x1

Gewindeanschluss M8x1
Threaded connector M8x1



GA-9.5-M10x1

Gewindeanschluss M10x1
Threaded connector M10x1



Kugelanschlüsse
Ball connector

KA-10-20

Kugelfadpter Ø 10 mm inkl.
Klemmring - 20 mm lang - für 1/8" System
Ball socket connector Ø 10 mm incl.
clamping ring - 20 mm long - for 1/8" System



KA-12-20

Kugelfadpter Ø 12 mm inkl.
Klemmring - 20 mm lang - für 1/8" System
Ball socket connector Ø 12 mm incl.
clamping ring - 20 mm long - for 1/8" System



Distanzstücke
Spacer

D-9.5-20

Distanzstück 20 mm
Spacer 20 mm



D-9.5-32

Distanzstück 32.5 mm
Spacer 32.5 mm



D-9.5-45

Distanzstück 45 mm
Spacer 45 mm

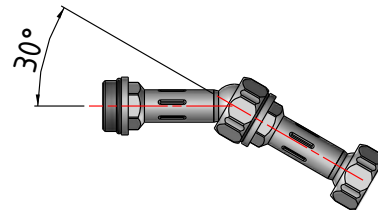
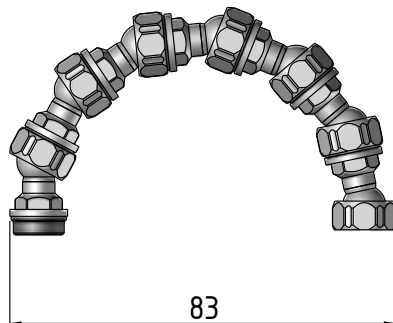
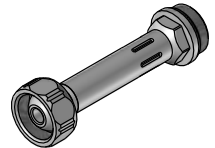

Düsen Nozzle

RD-9.5-1

Rund-Düse Ø 1.0 mm
Round nozzle Ø 1.0 mm



RD-9.5-2

Rund-Düse Ø 2.0 mm
Round nozzle Ø 2.0 mm



RD-9.5-3.4

Rund-Düse Ø 3.4 mm
Round nozzle Ø 3.4 mm



RD-9.5-5/1.0

Rund-Düse Mehrloch 5x Ø 1.0 mm
Round nozzle multihole 5x Ø 1.0 mm



SDK-9.5/60°

Spez-Düse 60° kurz
Special nozzle 60° short



SDL-9.5/60°

Spez-Düse 60° lang
Special nozzle 60° long



SDK-9.5/90°

Spez-Düse 90° kurz
Special nozzle 90° short



SDL-9.5/90°

Spez-Düse 90° lang
Special nozzle 90° long



Zubehör Accessories

M-SW13

Mutter SW13
Nut AF13



Ring 9.5

O-Ring 1/8"
O-ring 1/8"



S-9/13

Sechskantschlüssel 1/8"
Hexagon wrench 1/8"

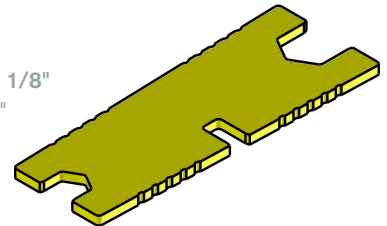

Winkелеlemente Elbows

L-1/8"

90° Winkelstück
90° elbow



Set Set

PCL-1/8" SET 1

Cooling Line Starterkit 1/8"

Cooling Line Starterkit 1/8" Inhalt:
Cooling Line starter kit 1/8" content:

- 2 x RD-9.5-1
- 2 x RD-9.5-2
- 2 x RD-9.5-3.4
- 2 x RD-9.5-5/1.0
- 2 x SDK-9.5/60°
- 2 x SDK-9.5/90°
- 2 x SDL-9.5/60°
- 2 x SDL-9.5/90°
- 3 x D-9.5/20
- 3 x D-9.5/32
- 3 x D-9.5/45
- 1 x L-1/8"
- 1 x GA-9.5-1/8"
- 1 x GA-9.5-1/8" NPT
- 1 x GA-9.5-M8
- 1 x GA-9.5-M8x1
- 1 x GA-9.5-M10x1
- 2 x S-9/13
- 5 x M-SW13

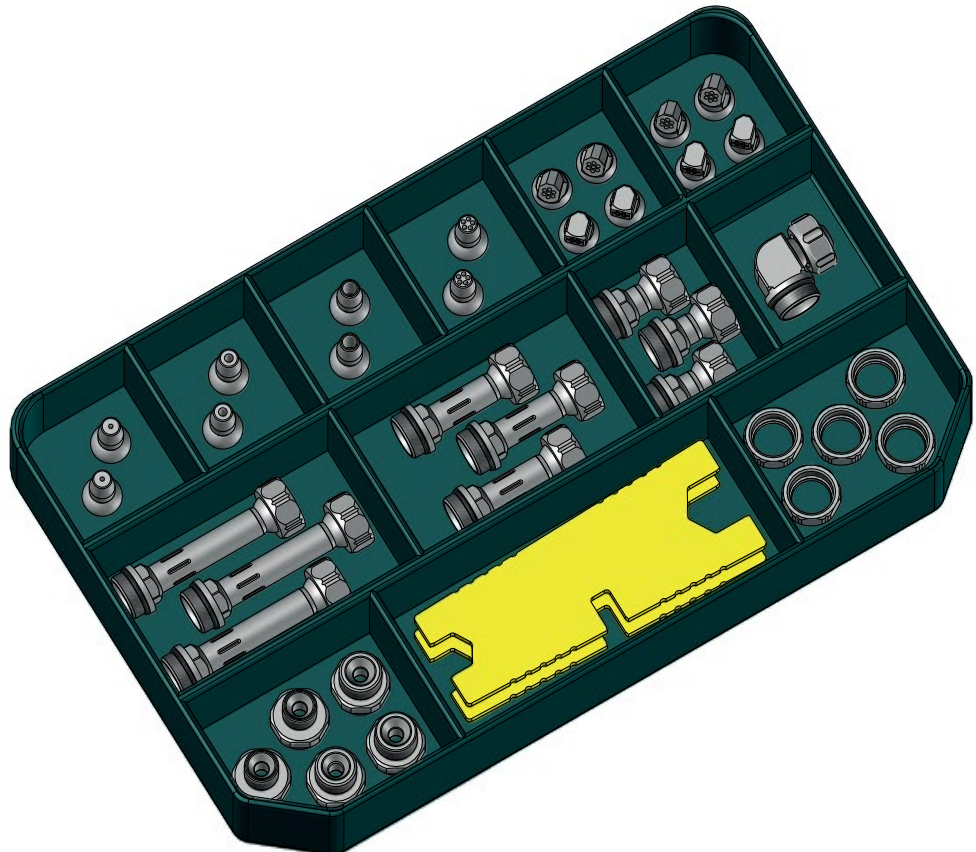

FOR HIGH
PRESSURE
80 BAR

Gewindeanschlüsse Threaded connector

GA-1/8"

Gewindeanschluss 1/8" G
Threaded connector 1/8" G



GA-1/8" NPT

Gewindeanschluss 1/8" NPT
Threaded connector 1/8" NPT



GA-R 1/8"

Gewindeanschluss 1/8" R
Threaded connector 1/8" R



GA-R1/8"-L

Gewindeanschluss R1/8" lang
Threaded connector R1/8" long

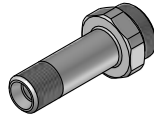

GA-1/4"

Gewindeanschluss 1/4"
Threaded connector 1/4"



GA-1/4" NPT

Gewindeanschluss 1/4" NPT
Threaded connector 1/4" NPT



GA-R 1/4"

Gewindeanschluss 1/4" R
Threaded connector 1/4" R



GA-R1/4"-L

Gewindeanschluss GA-R1/4" lang
Threaded connector GA-R1/4" long

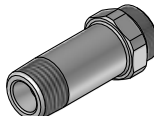

GA-M8

Gewindeanschluss M8
Threaded connector M8



GA-M8-L

Gewindeanschluss M8 lang
Threaded connector M8 long

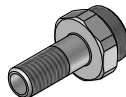

GA-M10

Gewindeanschluss M10
Threaded connector M10



GA-M10x1

Gewindeanschluss M10x1
Threaded connector M10x1



GA-M12x1

Gewindeanschluss M12x1
Threaded connector M12x1



GA-3/8" -1/4"

Gewindeanschluss 3/8" G
mit Reduktion auf 1/4" System
Threaded connector 3/8" G
with reduction to 1/4" system



GA-3/8" R -1/4"

Gewindeanschluss 3/8" R
mit Reduktion auf 1/4" System
Threaded connector 3/8" R
with reduction to 1/4" system



GA-R

Gewindeanschluss Rohling Ø 14 mm zur
Fertigung von kundenspezifischem Gewinde
Threaded connector blank Ø 14 mm for
production of customized thread

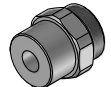

Kugelanschlüsse Ball connector

KA-12-28

Kugelpfadapter Ø 12 mm inkl. Klemmring
28 mm lang - für 1/4" System
Ball socket connector Ø 12 mm incl.
clamping ring - 28 mm long - for 1/4" System



KA-14-28

Kugelpfadapter Ø 14 mm inkl. Klemmring
28 mm lang - für 1/4" System
Ball socket connector Ø 14 mm incl.
clamping ring - 28 mm long - for 1/4" System



KA-15-28

Kugelpfadapter Ø 15 mm inkl. Klemmring
28 mm lang - für 1/4" System
Ball socket connector Ø 15 mm incl.
clamping ring - 28 mm long - for 1/4" System



R-12

Klemmring Ø 12 mm
Clamping ring Ø 12 mm



SDK-1260

Spez-Düse 60° kurz - Kugel Ø 12 mm
Special nozzle 60° short - ball Ø 12 mm



SDL-1260

Spez-Düse 60° lang - Kugel Ø 12 mm
Special nozzle 60° long - ball Ø 12 mm



R-12.5

Klemmring Ø 12.5 mm
Anwendbar mit Standard 1/4" Düsen
Clamping ring Ø 12.5 mm
Applicable with standard 1/4" nozzles



R-14

Klemmring Ø 14 mm
Clamping ring Ø 14 mm



SDK-1460

Spez-Düse 60° kurz - Kugel Ø 14 mm
Special nozzle 60° short - ball Ø 14 mm



SDL-1460

Spez-Düse 60° lang - Kugel Ø 14 mm
Special nozzle 60° long - ball Ø 14 mm



RDK-14715

Rund-Düse Mehrloch - Kugel Ø 14 mm
Round nozzle multihole - ball Ø 14 mm



R-15

Klemmring Ø 15 mm
Clamping ring Ø 15 mm



SDK-1560

Spez-Düse 60° kurz - Kugel Ø 15 mm
Special nozzle 60° short - ball Ø 15 mm



SDL-1560

Spez-Düse 60° lang - Kugel Ø 15 mm
Special nozzle 60° long - ball Ø 15 mm



RDK-15715

Rund-Düse Mehrloch - Kugel Ø 15 mm
Round nozzle multihole - ball Ø 15 mm



Distanzstücke Spacer

D-12.5/28

Distanzstück 28 mm
Spacer 28 mm



D-12.5/43

Distanzstück 43 mm
Spacer 43 mm

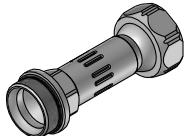

D-12.5/70

Distanzstück 70 mm
Spacer 70 mm

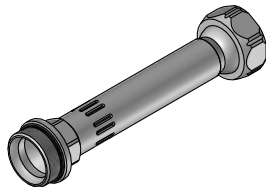

Winkelemente Elbows

L-12.5

90°-Winkelstück
90° elbow

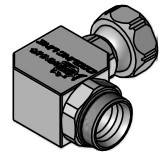

Quatro-12.5

Quatro-Verteilerblock
Quatro distribution block

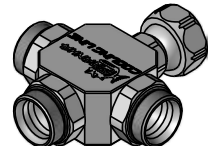

T-12.5

T-Verteilerstück
T-distributor

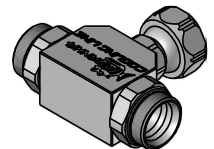

Y-12.5

Y-Verteilerstück
Y-distributor

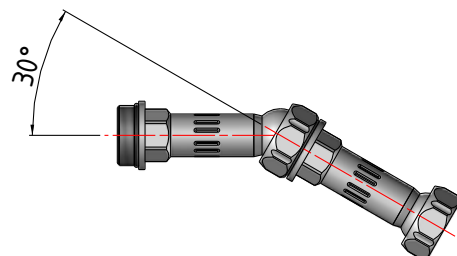
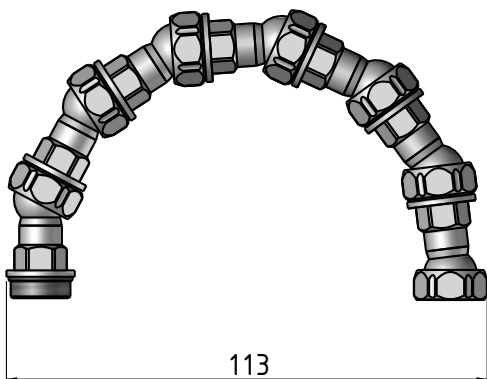
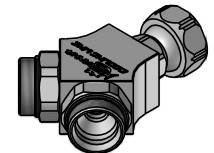

Düsen Nozzle

RD-12.5-1.5

Rund-Düse Ø 1.5 mm
Round nozzle Ø 1.5 mm



RD-12.5-3.5

Rund-Düse Ø 3.5 mm
Round nozzle Ø 3.5 mm



RD-12.5-4.5

Rund-Düse Ø 4.5 mm
Round nozzle Ø 4.5 mm



RD-12.5-5.5

Rund-Düse Ø 5.5 mm
Round nozzle Ø 5.5 mm



RD-12.5-7/1.5

Rund-Düse Mehrloch 7x Ø 1.5 mm
Round nozzle multihole 7x Ø 1.5 mm

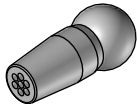

RD-12.5-3/2

Rund-Düse 3x Ø 2.0 mm
Round nozzle 3x Ø 2.0 mm



RD-12.5-4/1.5

Rund-Düse 4x Ø 1.5 mm
Round nozzle 4x Ø 1.5 mm



SDK-12.5/90°

Spez-Düse 90° kurz
Special nozzle 90° short

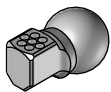

SDL-12.5/90°

Spez-Düse 90° lang
Special nozzle 90° long

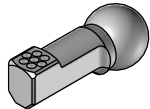

SDK-12.5/60°

Spez-Düse 60° kurz
Special nozzle 60° short



SDL-12.5/60°

Spez-Düse 60° lang
Special nozzle 60° long



FDL-12.5-20

Flachdüse 20 mm
Flat nozzle 20 mm

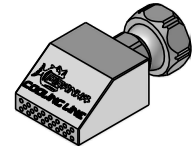

LDK-12.5-12x1

Längsdüse kurz 12x Ø 1 mm
Diagonal nozzle short 12x Ø 1 mm

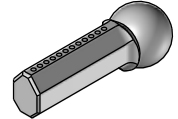

LDL-12.5-18x1

Längsdüse lang 18x Ø 1 mm
Diagonal nozzle long 18x Ø 1 mm

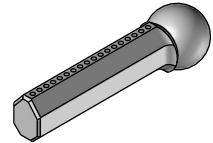

Zubehör Accessories

M-SW16

Mutter SW16
Nut AF16



D-SW16

Verschluss-Deckel SW16
Cap AF16



Ring 12.5

O-Ring 1/4"
O-ring 1/4"



S-11/16

Sechskantschlüssel 1/4"
Hexagon wrench 1/4"

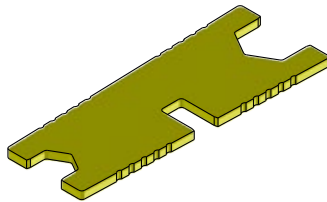

H-12.5

Kugelhahn 1/4"
Ball valve 1/4"



Spezialanfertigung Customized products

Können nach Kundenwunsch produziert werden.
Can be produced by request.

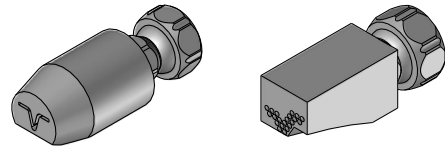

Sets

Sets

PCL-1/4 SET 1 Cooling Line Starterkit 1/4"

Cooling Line Starterkit 1/4" Inhalt:
Cooling Line starter kit 1/4" content:

- 1 x GA-1/4"
- 1 x GA-1/4" NPT
- 1 x GA-1/8" NPT
- 1 x GA-M10x1
- 1 x GA-M12x1
- 1 x RD-12.5-3.5
- 1 x RD-12.5-4.5
- 1 x RD-12.5-5.5
- 1 x RD-12.5-7/1.5
- 1 x SDL-12.5/60°
- 1 x SDL-12.5/90°
- 1 x SDK-12.5/60°
- 1 x SDK-12.5/90°
- 5 x M-SW16
- 3 x D-12.5/28
- 3 x D-12.5/43
- 3 x D-12.5/70
- 1 x Y-12.5
- 2 x S-11/16
- 1 x L-12.5

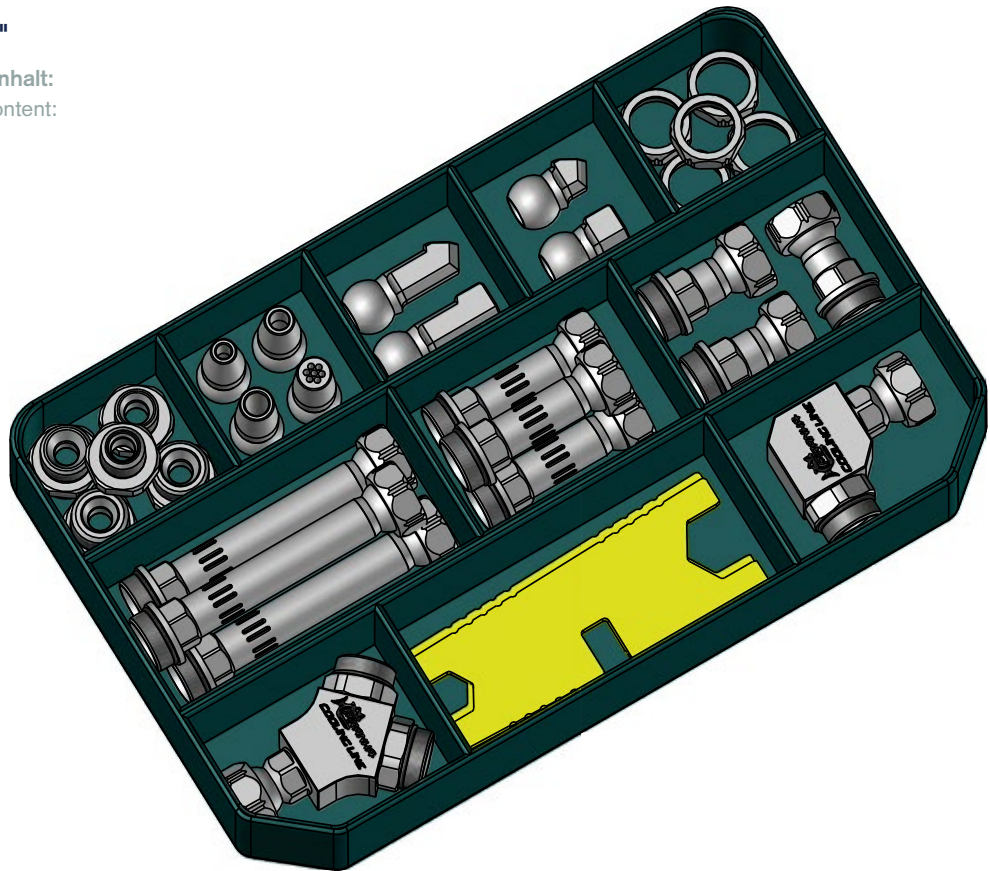



CR-12.5-8 Cooling Ring mit 8 Düsen

Cooling ring with 8 nozzles

Zusammengestellt aus:
Composed by:

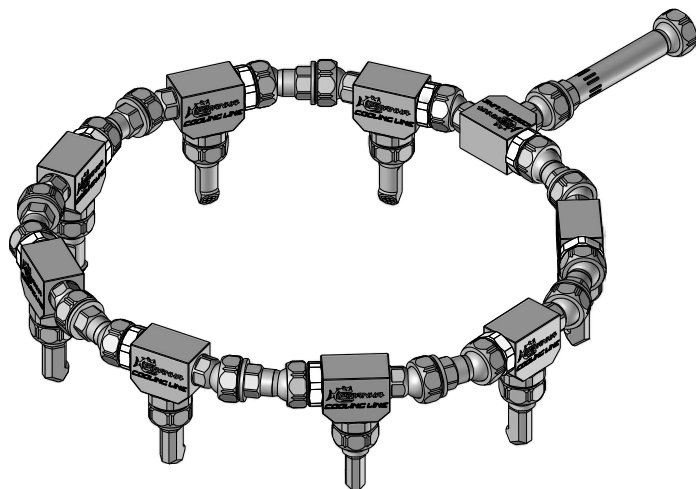
- 1 x D-12.5/70
- 9 x T-12.5 spezial
- 9 x D-12.5/28
- 8 x M-SW16
- 8 x SDL-12.5/60°





FOR HIGH
PRESSURE
80 BAR

Gewindeanschlüsse Threaded connector

GA-22-3/8" NPT

Gewindeanschluss 3/8" NPT
Threaded connector 3/8" NPT

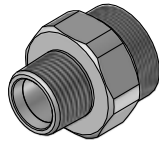

GA-22-3/8"

Gewindeanschluss 3/8"
Threaded connector 3/8"

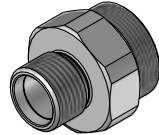

GA-22-R-3/8"

Gewindeanschluss 3/8" R
Threaded connector 3/8" R

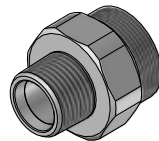

GA-22-1/2" NPT

Gewindeanschluss 1/2" NPT
Threaded connector 1/2" NPT

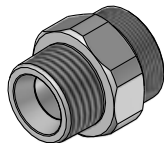

GA-22-1/2"

Gewindeanschluss 1/2" G
Threaded connector 1/2" G

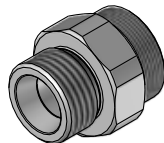

GA-22-R 1/2"

Gewindeanschluss 1/2" R
Threaded connector 1/2" R

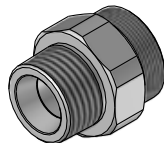

GA-R-22

Gewindeanschluss Rohling Ø 24 mm
zur Fertigung von kundenspezifischem
Gewinde
Threaded connector blank Ø 24 mm for
production of customized thread

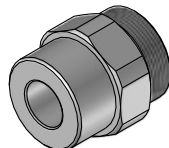

GA-3/8" -1/4"

Gewindeanschluss 3/8" G mit
Reduktion auf 1/4" System
Threaded connector 3/8" G with
reduction to 1/4" system



GA-3/8" R -1/4"

Gewindeanschluss 3/8" R mit
Reduktion auf 1/4" System
Threaded connector 3/8" R with
reduction to 1/4" system



GA-3/4"-1/2"

Gewindeanschluss 3/4" G mit
Reduktion auf 1/2" System
Threaded connector 3/4" G with
reduction to 1/2" system

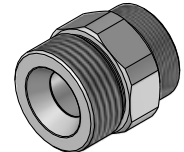

Distanzstücke Spacer

D-22-38

Distanzstück 38 mm
Spacer 38 mm

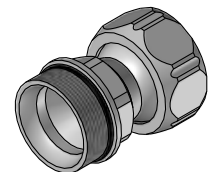

D-22-46

Distanzstück 46.5 mm
Spacer 46.5 mm

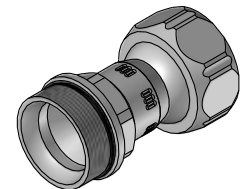

D-22-63

Distanzstück 63.5 mm
Spacer 63.5 mm

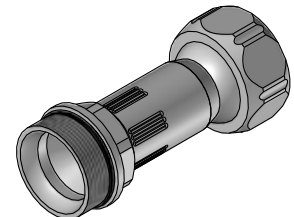

D-22-80

Distanzstück 80 mm
Spacer 80 mm

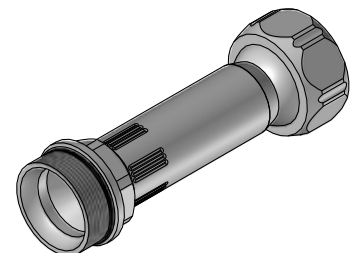

Düsen Nozzle

RD-22-6

Rund-Düse Ø 6 mm
Round nozzle Ø 6 mm

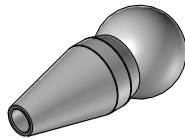

RD-22-8

Rund-Düse Ø 8 mm
Round nozzle Ø 8 mm

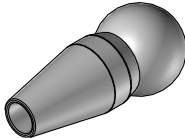

RD-22-10

Rund-Düse Ø 10 mm
Round nozzle Ø 10 mm

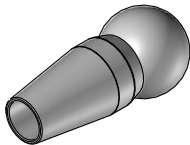

RD-22-12-19.2

Rund-Düse Mehrloch 19x Ø 2 mm
Round nozzle multihole 19x Ø 2 mm

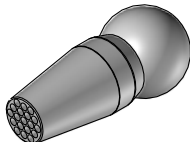

SDK-22/60°

Spez-Düse 60° kurz
Special nozzle 60° short

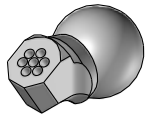

SDL-22/60°

Spez-Düse 60° lang
Special nozzle 60° long

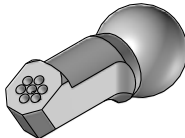

SDK-22/90°

Spez-Düse 90° kurz
Special nozzle 90° short

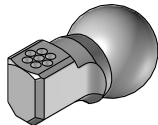

SDL-22/90°

Spez-Düse 90° lang
Special nozzle 90° long

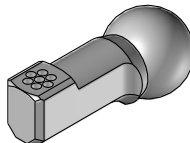

LDK-22-16x2

Längsdüse kurz 16x Ø 2 mm
Diagonal nozzle short 16x Ø 2 mm

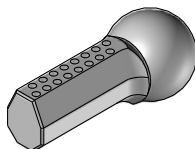

LDL-22-24x2

Längsdüse lang 24x Ø 2 mm
Diagonal nozzle long 24x Ø 2 mm

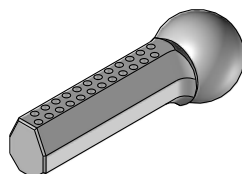

Winkelemente Elbows

L-1/2"

90°-Winkelstück
90° elbow

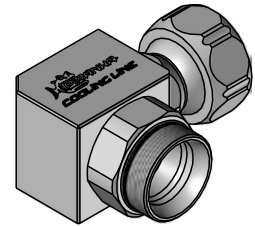

T-1/2"

T-Verteilerstück
T-distributor

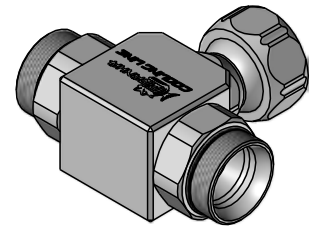

Y-1/2"

Y-Verteilerstück
Y-distributor

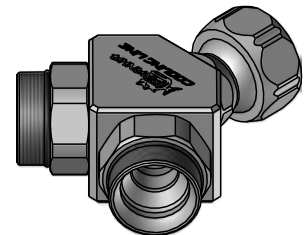

Y-1/2"-1/4"

Y-Verteilerstück
Y-distributor

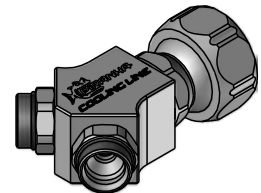

Flachdüsen Flat nozzle

FD-22-30

Flachdüse 30 mm
Flat nozzle 30 mm

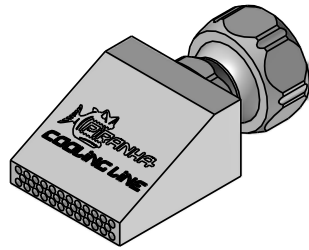

FD-22-40

Flachdüse 40 mm
Flat nozzle 40 mm



FD-22-50

Flachdüse 50 mm
Flat nozzle 50 mm

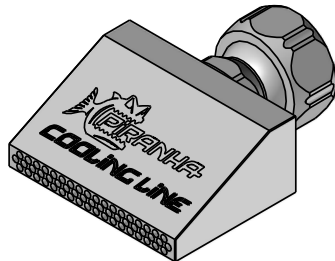

FD-22-60

Flachdüse 60 mm
Flat nozzle 60 mm



FD-22-80

Flachdüse 80 mm
Flat nozzle 80 mm



FD-22-100

Flachdüse
100 mm
Flat nozzle
100 mm

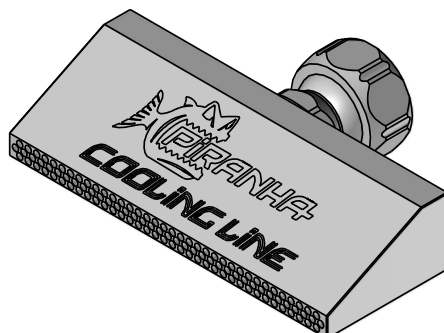

Zubehör Accessories

M-SW27

Mutter SW27
Nut AF27

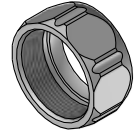

D-SW27

Verschluss-Deckel SW27
Cap AF27

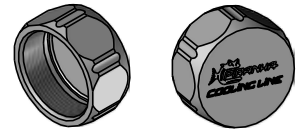

Ring 22

O-Ring 1/2"
O-ring 1/2"



S-21/27

Sechskantschlüssel 1/2"
Hexagon Wrench 1/2"

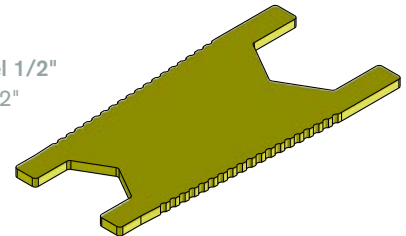

H-22

Kugelhahn 1/2"
Ball valve 1/2"

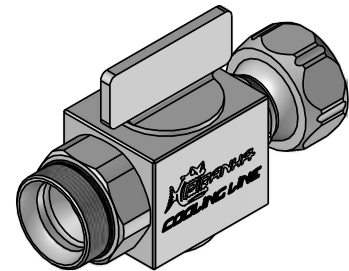

RVD-22

Rückschlagventil im Distanzstück
Check valve integrated in spacer

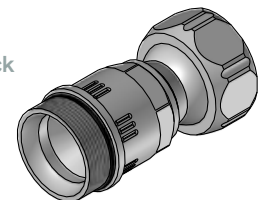

Set Set

PCL-1/2" SET 1 Cooling Line Starterkit 1/2"

Cooling Line Starterkit 1/2" Inhalt:
Cooling Line starter kit 1/2" content:

- 1 x RD-22-6
- 1 x RD-22-8
- 1 x RD-22-10
- 1 x RD-22-12-19.2
- 1 x SDK-22/60
- 1 x SDK-22/90
- 1 x SDL-22/60
- 1 x SDL-22/90
- 5 x M-SW27
- 8 x D-22-46
- 1 x L-1/2"
- 4 x D-22-63
- 4 x D-22-80
- 2 x GA-22-1/2"
- 2 x GA-22-1/2" NPT
- 2 x GA-22-3/8"
- 2 x GA-22-3/8" NPT
- 2 x S-21/27

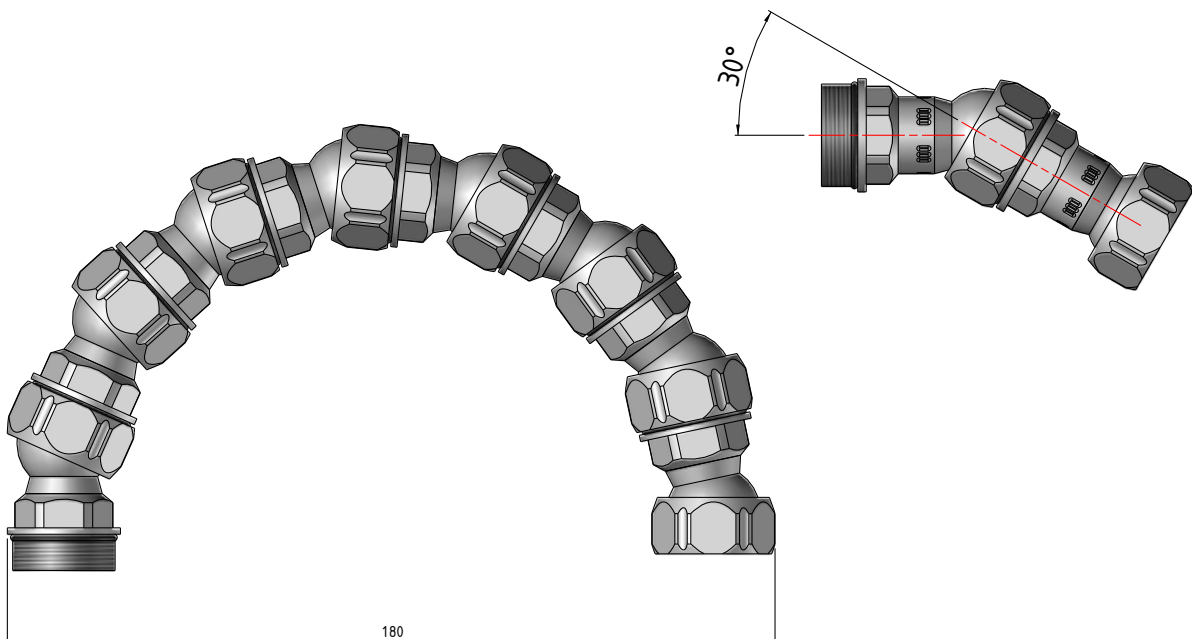
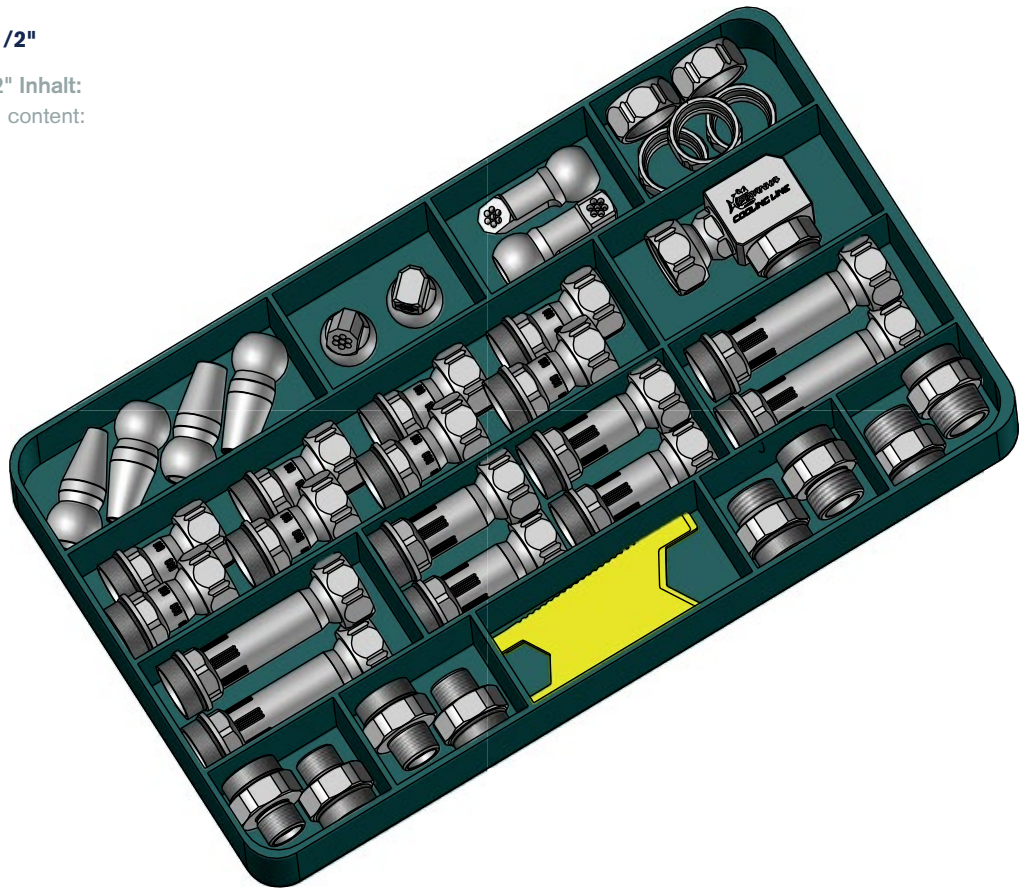



Klostermatt 14 · CH-6330 Cham

Telefon: +41 41 780 17 88

info@piranha-clamp.com · www.piranha-clamp.com



Abbildungen können vom Original abweichen. Änderungen jederzeit ohne Vorankündigung vorbehalten. Jede Nachbildung des Produktes, gleich ob ganz oder teilweise, sowie der zugehörigen Technologien ist untersagt. Piranha Cooling Line® ist ein registrierter Name. Technische Änderungen und Irrtümer vorbehalten.
All illustrations are for reference only. The datas are subject to change. A copy of the product, whether in whole or in part, and the related technologies is prohibited. Piranha Cooling Line® is a registered name. Technical amendments and errors may occur.